



The Maxi rotary spray head provides a rotating fan cleaning action using low volumes of liquid at low pressure. It is an automatic device for cleaning medium size tanks and a more efficient replacement for traditional fixed sprayballs or manual methods used in tank cleaning.

APPLICATIONS

Hygienic and non-hygienic industries can benefit from the use of the Maxi in tanks ranging from 5 to 50m³ (1 300 to 13 000 US gallons).

OPERATION

The flow of the cleaning fluid causes the body of the cleaning head to rotate providing a swirling impact. Three spray patterns 360°, 270° and 180° are available to suit various tank designs.

SPRAY CHARACTERISTICS

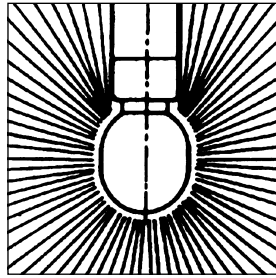

360°

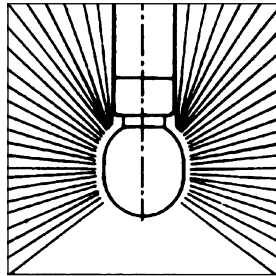

270°

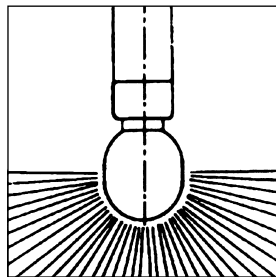

180° Down

ORDERING INFORMATION

Please specify desired spray pattern and required connections.

SPECIFICATIONS

Materials

Housing: SAF 2205 (UNS 31803)
Balls: AISI 316. Others: AISI 316L

Weight

Thread and clip-on: 0,76 kgs (1,48 lbs)
On pipe: 0,97/1,52 kg (2,14/3,35 lbs)

Lubricant

Self-lubricating with the cleaning fluid

Working pressure

1-3 Bar (14,5-44 psi)

Recommended pressure

2 Bar (29 psi)

Max. working temperature

95 °C (203 °F)

Max. ambient temperature

140 °C (284 °F)

Wetting radius

Max. 3 m (10 ft.)

Impact cleaning radius

Max. effective 2 m (6,6 ft.)

Connection

1 1/4" BSP or NPT thread, clip-on, or welded on pipe

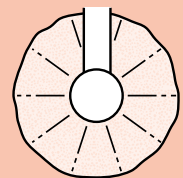

Contact our Helpline for any special requirements:
Tel: +44 (0) 151 424 6821
Fax: +44 (0) 151 495 1043
e-mail: sales@delavan.co.uk
Web: www.delavan.co.uk

FLOW RATE

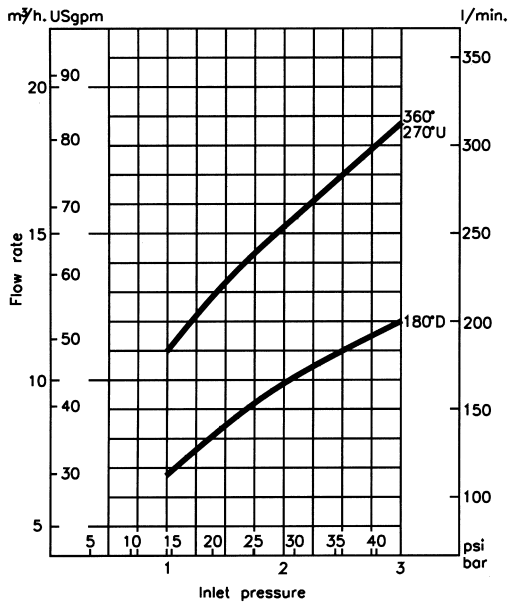

CLEANING RADIUS

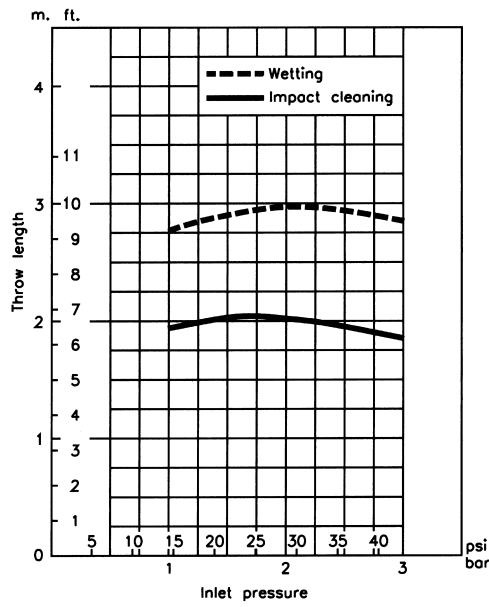

For Clip-on models, the flow rate is increased by approx. 10%.

DIMENSIONS

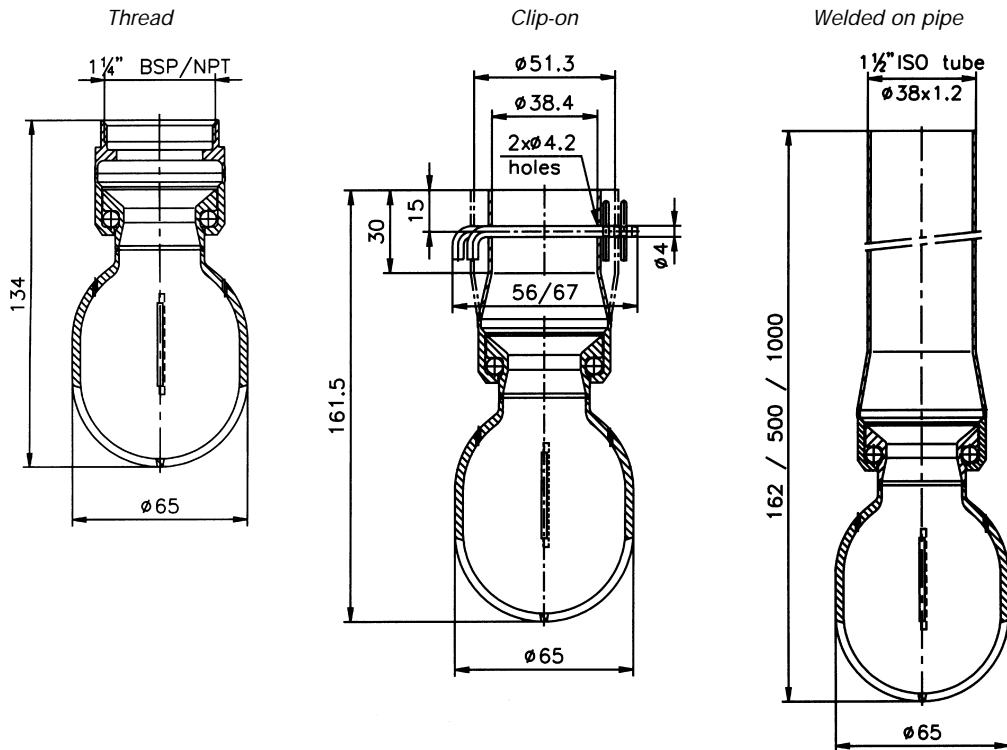

CLEANING IN PLACE

TYPE MAXI

Contact our Helpline for any special requirements:
Tel: +44 (0) 151 424 6821
Fax: +44 (0) 151 495 1043
e-mail: sales@delavan.co.uk
Web: www.delavan.co.uk

